



(12)外观设计专利

(10)授权公告号 CN 305114634 S

(45)授权公告日 2019.04.16

(21)申请号 201830610803.8

(22)申请日 2018.10.31

(73)专利权人 浙江三花汽车零部件有限公司
地址 310018 浙江省杭州市经济技术开发区12号大街301号

(72)设计人 不公告设计人

(51)LOC(12)CI.
12-16

图片或照片 56 幅 简要说明 1 页

(54)使用外观设计的产品名称
控制阀

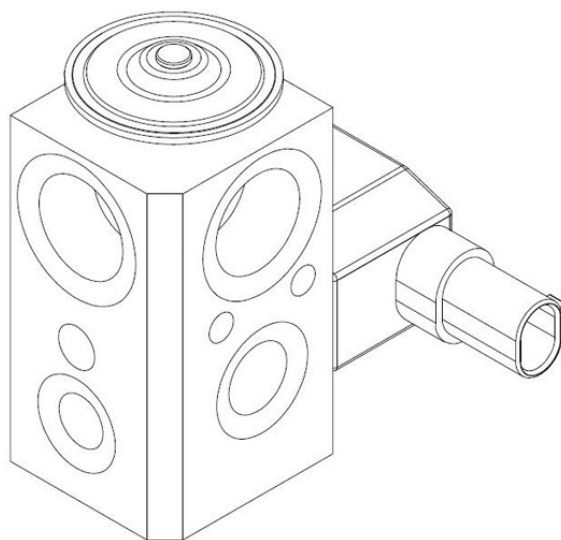

设计1立体图

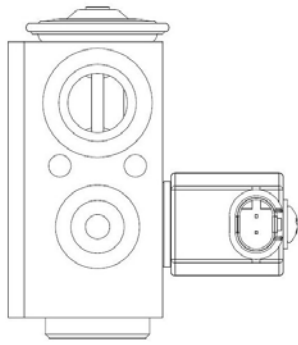

设计1主视图

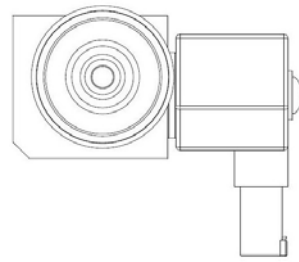

设计1俯视图

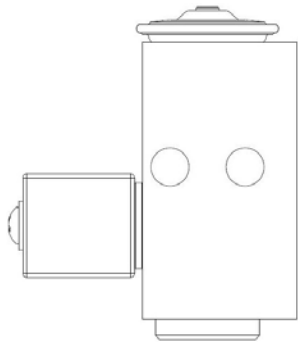

设计1后视图

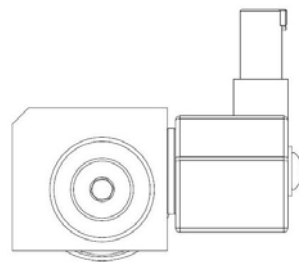

设计1仰视图

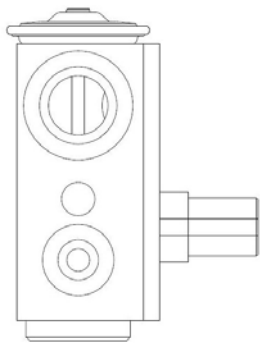

设计1左视图

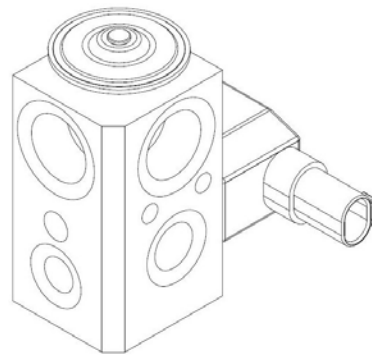

设计1立体图

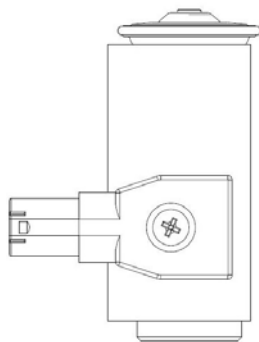

设计1右视图

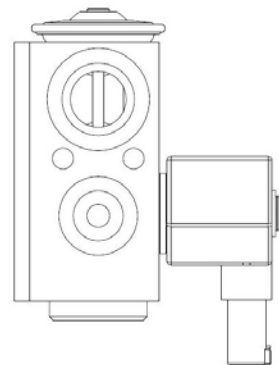

设计2主视图

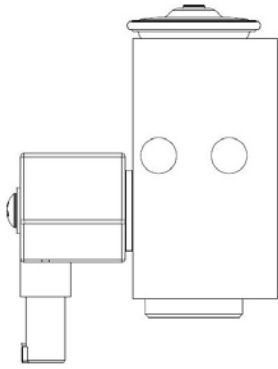

设计2后视图

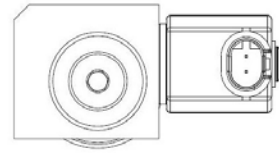

设计2仰视图

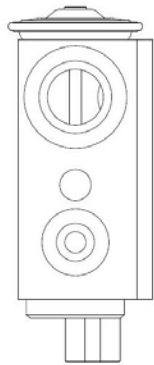

设计2左视图

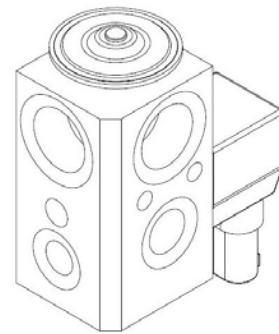

设计2立体图

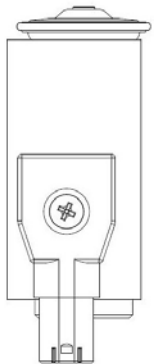

设计2右视图

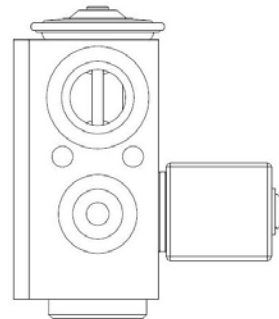

设计3主视图

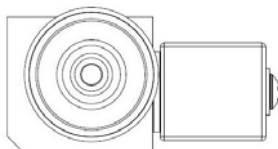

设计2俯视图

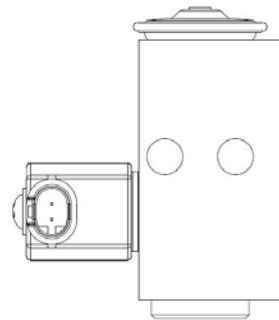

设计3后视图

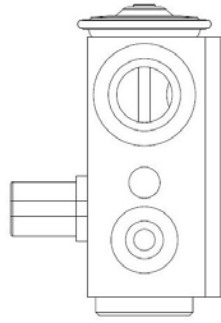

设计3左视图

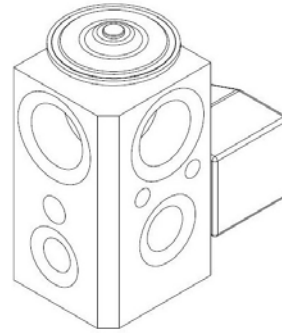

设计3立体图

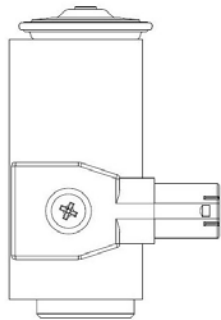

设计3右视图

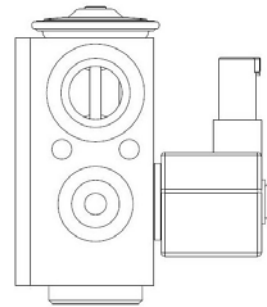

设计4主视图

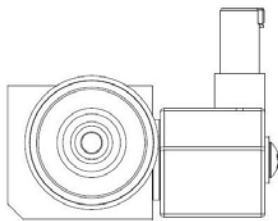

设计3俯视图

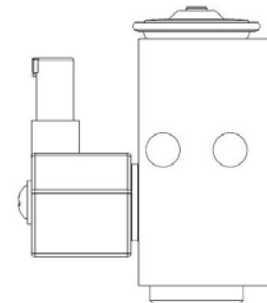

设计4后视图

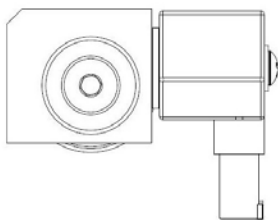

设计3仰视图

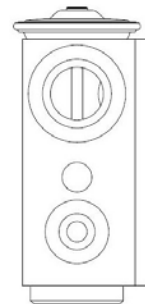

设计4左视图

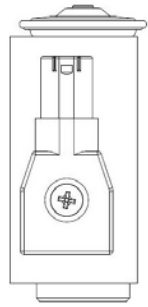

设计4右视图

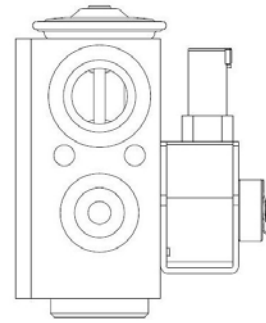

设计5主视图

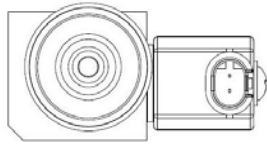

设计4俯视图

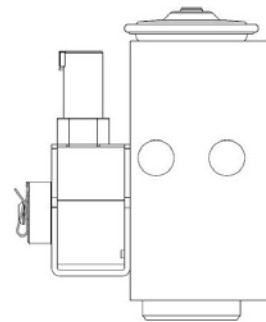

设计5后视图

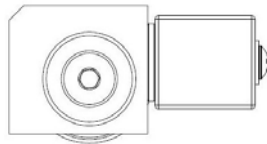

设计4仰视图

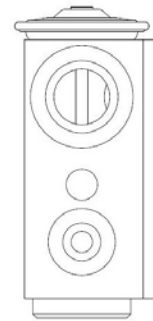

设计5左视图

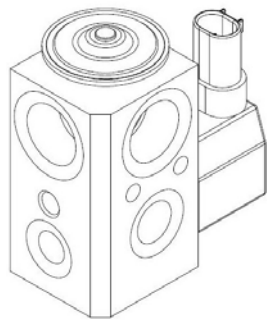

设计4立体图

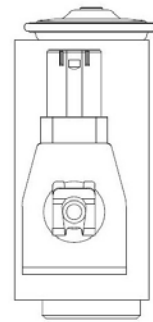

设计5右视图

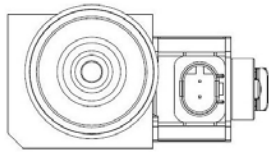

设计5俯视图

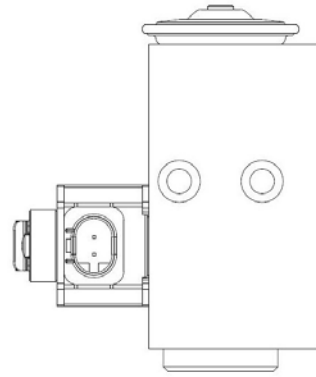

设计6后视图

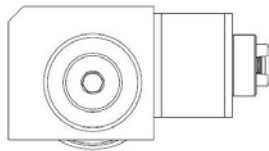

设计5仰视图

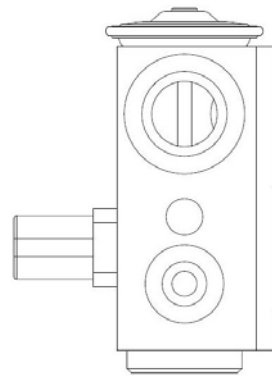

设计6左视图

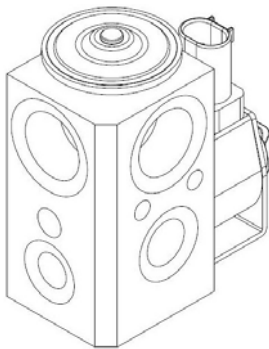

设计5立体图

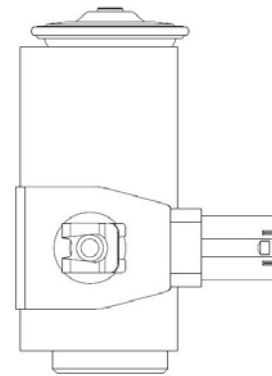

设计6右视图

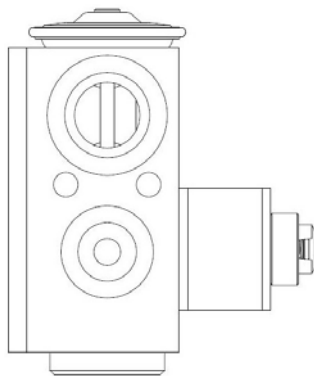

设计6主视图

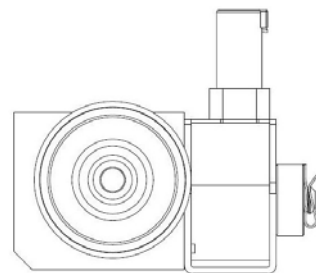

设计6俯视图

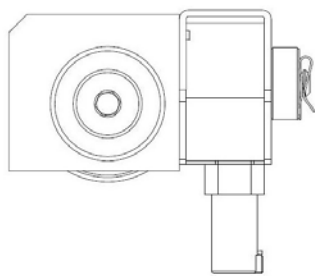

设计6仰视图

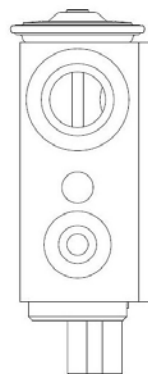

设计7左视图

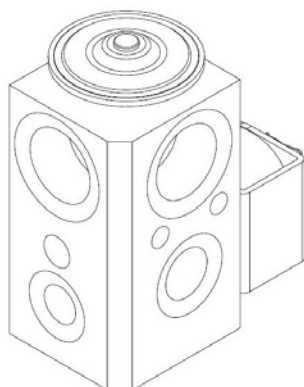

设计6立体图

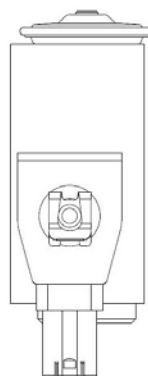

设计7右视图

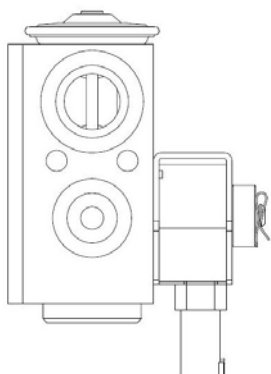

设计7主视图

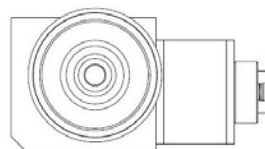

设计7俯视图

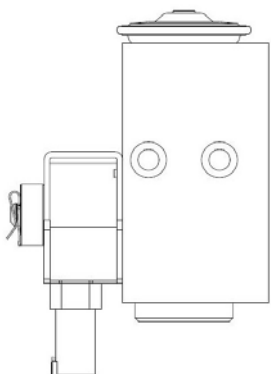

设计7后视图

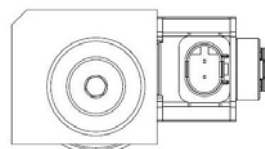

设计7仰视图

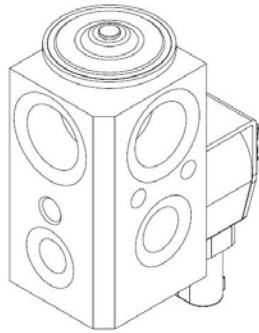

设计7立体图

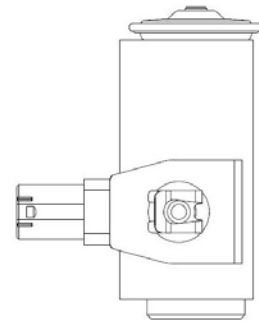

设计8右视图

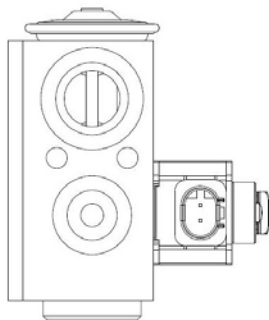

设计8主视图

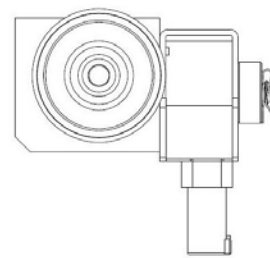

设计8俯视图

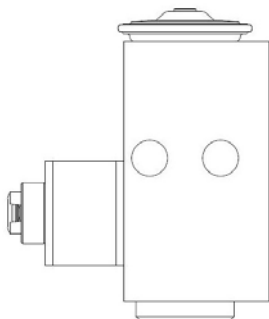

设计8后视图

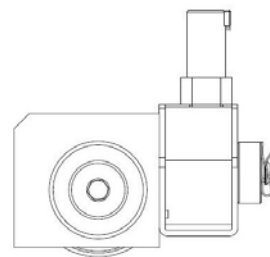

设计8仰视图

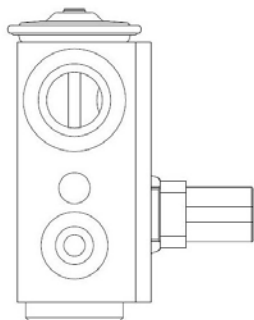

设计8左视图

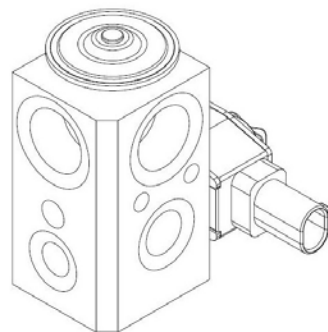

设计8立体图

1. 本外观设计产品的名称:控制阀。
2. 本外观设计产品的用途:用于车辆热管理系统,尤其用于空调系统或电池冷却系统。
3. 本外观设计产品的设计要点:控制阀的形状。
4. 最能表明本外观设计设计要点的图片或照片:设计1立体图。
5. 设计1为基本设计,设计1-8为相似外观设计。